

Technical specification

- 1 Seat, backrest, headrest** - upholstery (NEW1T, NEW2T), plywood (NEW1W, NEW2W)
2 Armrests - metal (right + left) in frame colour; OPTION WITH EXTRA CHARGE - for seat, backrest NEW1T, NEW1W

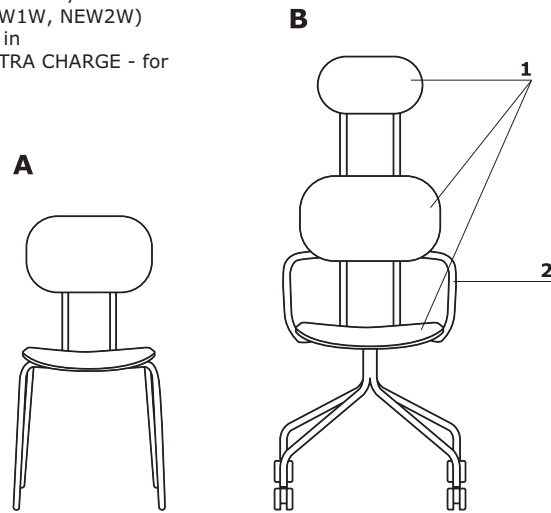

A - NEW1T, NEW1W, B - NEW2T, NEW2W; max. load 120 kg

Bases

1 Base N01:

- 4 - legged metal frame
- frame made of tube Ø18 mm, wall thickness 2 mm, powder coated

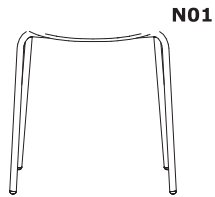

2 Base N07:

- 4 - star metal frame
- frame made of tube Ø18 mm, wall thickness 2 mm, powder coated
- swivel seat - 360°

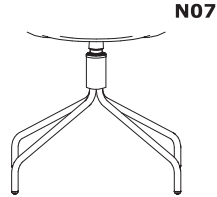

3 Base N03K:

- 4 - star metal frame
- castors for soft floors
- frame made of tube Ø18 mm, wall thickness 2 mm, powder coated
- fixed seat

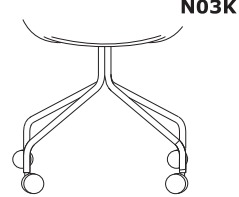

4 Base N04H:

- low stool
- 4 - legged metal frame
- frame made of tube Ø18 mm, wall thickness 2 mm, powder coated

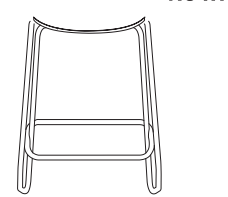

5 Base N05H:



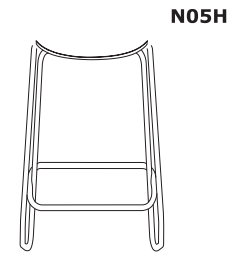

- high stool
- 4 - legged metal frame
- frame made of tube Ø18 mm, wall thickness 2 mm, powder coated

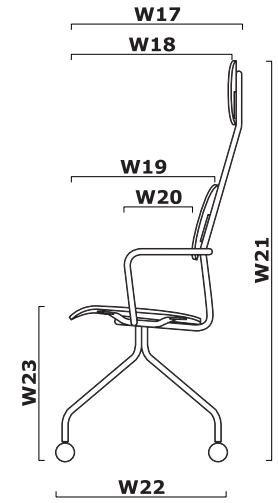
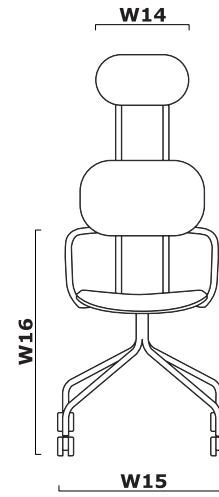
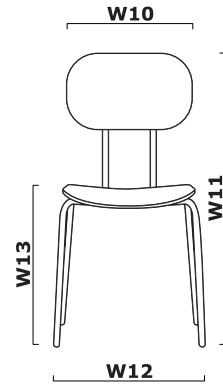
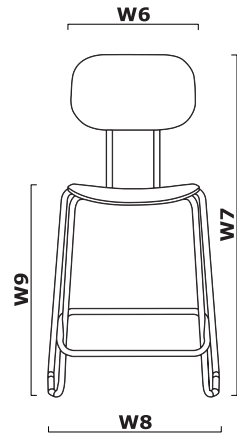
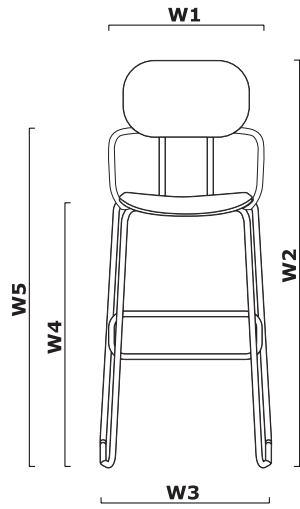









Dimensions (mm)





W1 - 535 | W2 - 1175 | W3 - 517 | W4 - 820 | W5 - 1025 | W6 - 420 | W7 - 995 | W8 - 517 | W9 - 640 | W10 - 390 | W11 - 817 | W12 - 458 | W13 - 462 | W14 - 330 | W15 - 550 |
W16 - 670 | W17 - 603 | W18 - 543 | W19 - 420 | W20 - 250 | W21 - 1186 | W22 - 550 | W23 - 46 |

Symbol: NEW1T								
	Base	Frame	III	IV	Armrests	Castors for hard floors	kg m3 pcs	Additional information
			Note	Alcantara				
	N01	metal					7 0,299 1	
		chrome						
	N07	metal					7 0,299 1	
		chrome						
	N03K	metal					7 0,299 1	
		chrome						
	N04H	metal					8 0,349 1	only for NEW1T, NEW1W seat, backrest
		chrome						
	N05H	metal					9 0,406 1	
		chrome						

Symbol: NEW2T								
	Base	Frame	III	IV	Armrests	Castors for hard floors	kg m3 pcs	Additional information
			Note	Alcantara				
	N01	metal					9 0,424 1	
		chrome						
	N07	metal					9 0,424 1	
		chrome						
	N03K	metal					9 0,424 1	
		chrome						

Symbol: NEW1W							
	Base	Frame	Plywood	Armrests	Castors for hard floors	kg m3 pcs	Additional information
	N01	metal				7 0,299	only for NEW1T, NEW1W seat, backrest
		chrome				1	
	N07	metal				7 0,299	
		chrome				1	
	N03K	metal				7 0,299	
		chrome				1	
	N04H	metal				8 0,349	
		chrome				1	
	N05H	metal				9 0,406	
		chrome				1	

Symbol: NEW2W							
	Base	Frame	Plywood	Armrests	Castors for hard floors	kg m3 pcs	Additional information
	N01	metal				9 0,424	
		chrome				1	
	N07	metal				9 0,424	
		chrome				1	
	N03K	metal				9 0,424	
		chrome				1	