

Kolekcja Chic:

Chic, Chic Air, Chic Lounge,
Chic Stoliki



profim



„Zarówno Chic, jak i Chic Air są propozycją wprowadzenia bardziej domowego klimatu do świata mebli kontraktowych. Chic reprezentuje klasyczny i elegancki charakter, podczas gdy Chic Air wpasuje się w minimalistyczne i nowoczesne wnętrza”.

Christophe Pillet
Projektant kolekcji

Kolekcja Chic Air:



reddot design award
winner 2017



Kolekcja Chic Lounge:



reddot design award
winner 2019



Minimalizm. Lekkość. Elegancja.

Chic

Chic to kolekcja wyróżniająca się lekkością, szykiem i ponadczasowym designem. Uwagę zwracają delikatne przekroje tworzące wizualny efekt niezwykłej lekkości. W rodzinie znajdziemy krzesło na cienkim metalowym stelażu, na bazie czteroramiennej lub w wersji na drewnianych nogach, hoker oraz fotel na bazie obrotowej (z funkcją pamięci powrotu) lub w wersji na stopkach.









Niebanalne wnętrza potrzebują wyjątkowych mebli. Efektowne krzesła i fotele z kolekcji Chic nie dominują we wnętrzu, ale zwracają uwagę subtelną linią przekroju oraz czystą formą.

Elegancja i harmonia

Chic to uniwersalny styl i kompaktowy kształt – to, co najważniejsze w mniej formalnych, ale wciąż eleganckich przestrzeniach jak pokoje hotelowe, kawiarnie, restauracje, strefy dla gości czy biurowe lobby. Ich uzupełnieniem są stoliki, które w połączeniu z siedziskami tworzą spójną całość, nadając wnętrzom harmonijny styl.





Funkcjonalność i jakość wykonania

Do miejsc, w których liczą się funkcjonalność i piękno, pasują krzesła na czteroramiennej bazie, które idealnie sprawdzą się w salach konferencyjnych i reprezentacyjnych przestrzeniach biurowych. Dzięki funkcji pamięci powrotu ułatwią też zachowanie porządku.







Synergia

Oryginalnym rozwiązaniem jest model krzesła bez podłokietników. Ciekawy design nieodbiegający charakterem od reszty foteli z kolekcji pozwoli w ciekawy sposób zbudować przestrzeń sprzyjającą kreatywnym spotkaniom.



Jeszcze większa kolekcja

Krzęsta barowe stanowią kompletne uzupełnienie oferty kolekcji Chic. Eleganckie, lekkie i wysublimowane kształty osadzone na dwóch rodzajach podstaw zapraszają do skorzystania i wypróbowania. Charakterystyczne proste linie wyróżniające produkt idealnie współgrają z długimi i wysokimi barowymi ładami.





ESPRESSO

AMERICANO 2.90 2.60
CAPPUCCINO 2.80 3.50

LATTE 2.40
FLAT WHITE 3.20
MILCHKAFFEE 3.80
ESPRESSO 3.00

ESPRESSO

KAKAO 2.00 2.10
KAKAO MIT 1.80 2.50

EXTRA SAHNE 1.40
EXTRA SHOT 1.20
EXTRA / SOJA 3.50
HOT CHOCOLATE 3.00

SOFTDRINKS

WASSER LAIT 6.3 1.50
APFELCHOCOLATE 0.3 2.80

CHARITEA 0.3 3.50
COKA COLA 0.2 2.40
FRITZ KOLA 0.2 2.40
PETZ PAN 0.3 4.50



Chwila relaksu

Kubetki foteli Chic swoją estetyczną i subtelną formą zapraszają do relaksu i wpasowują się w atmosferę niezobowiązujących spotkań.

Fotele przeznaczone są dla stref relaksu. Profilowany kształt kubetka i miękkie pianki pozwalają na odpoczynek w pełnym komforcie.



Chic Air

Chic Air to niezwykle eleganckie meble, które wyróżnia minimalistyczny, wysublimowany kształt. Linia składa się z kompaktowych krzeseł i ławek oraz utrzymanych w tej samej konwencji charakterystycznych foteli. Wszystkie modele są dostępne na cienkim metalowym stelażu lub na drewnianych nogach.





reddot design award
winner 2017





Chic Air został zaprojektowany z myślą o nowoczesnych, minimalistycznych przestrzeniach – z potrzeby stworzenia siedzisk, które wpasowałyby się w ich estetykę. Dzięki zaawansowanym procesom technologicznym nadano pianie subtelną formę. Wysublimowane i przemyślane kształty sprawiają, że meble Chic Air są elementem przykuwającym uwagę we wnętrzu.



NEW YORK



LONDON



TOKYO







Geometria kształtów

Kolekcja oparta jest o kanciaste, geometryczne formy połączone z delikatnymi przekrojami stelaża podtrzymującego całość. Fotele Chic Air to idealna opcja dla osób planujących wyposażać przestrzeń lobby, gabinetu czy strefy lounge w wyjątkowo komfortowe, wyróżniające się wysmakowanym designem oraz starannym wykonaniem siedziska.



Idealne dopasowanie

Oryginalne cienkie przekroje produktów Chic Air zostały uzyskane dzięki zaawansowanej konstrukcji dwóch kubetków połączonych bez widocznych elementów łączących. Charakteru kolekcji dodaje możliwość połączenia dwóch różnych powierzchni tapicerowanych – wysokogatunkowej skóry na zewnątrz i miękkiej tapicerki wewnątrz kubetka.





Chic Lounge

Zachwyca miękkimi liniami, lekkością i starannie zaprojektowanym kształtem, który zapewnia komfort użytkowania. Dostępny jest w dwóch wariantach – z nowoczesnym stelażem z metalowego pręta oraz subtelną czteroramienną bazą. Fotel występuje zarówno w wersji z wysokim, jak i niskim oparciem. Uzupełnieniem kolekcji jest elegancki podnózek oraz miękka poduszka nakładana na wysokie oparcie.





reddot design award
winner 2019

top
design
award
2019



Stylowa strefa relaksu

Kolekcja została stworzona z myślą o nowoczesnych strefach relaksu, stanowiących istotny element przestrzeni biurowej i hotelowej. Fotele mają wyjątkowo wygodne siedziska, które zachęcają do wypoczynku i swobodnych spotkań. Ergonomiczne oparcie pozwala się odprężyć, a starannie przemyślane dodatki podkreślają nieformalny charakter kolekcji.





Zastużony odpoczynek

Model na cienkiej czteroramiennej bazie umożliwia delikatne kołysanie, które odpręża i gwarantuje chwilę wytchnienia. Połączenie efektownego wzornictwa i komfortowego siedziska sprawia, że fotel stanowi idealne uzupełnienie eleganckiego wnętrza.







Wzornictwo i komfort

Meble z kolekcji Chic Lounge doskonale łączą minimalistyczny design z ponadprzeciętną wygodą. Wyróżniają się szlachetnym wykończeniem, finezyjnym połączeniem miękkiej tkaniny z elegancką skórą oraz troską o detale – uwagę zwracają misterne przeszycia i subtelne linie. Dzięki zróżnicowanej kolorystyce fotele znakomicie wpiszą się w przestrzeń zaaranżowaną w różnych stylach, a ich lekka forma nie przytłoczy wnętrza.



Chic Stoliki

Kolekcja oferuje szeroki wybór baz, kształtów i wielkości blatów oraz wysokości stolików, których styl można dodatkowo konfigurować dzięki szerokiej gamie wykończeń. To sprawia, że stoliki można wykorzystać w dowolnej przestrzeni, zachowując jej jednolity wystrój i charakter.



RR Tables



RR40



RR30



RR20



RR10

RH Tables



RH30



RH20

CR Tables



CR40



CR41

CS Tables



CS30



CS40



CS41



Stylowa różnorodność

Stoliki Chic stanowią naturalne uzupełnienie rodziny mebli Chic i Chic Air. Dzięki spójnej, eleganckiej stylistyce i lekkości form stoliki i siedziska tworzą całościową koncepcję aranżacji przestrzeni. Cztery dostępne wykończenia blatu – z ceramiki, szkła, drewna lub blachy – pozwalają na wykreowanie wnętrza w dowolnym stylu.



Ceramics

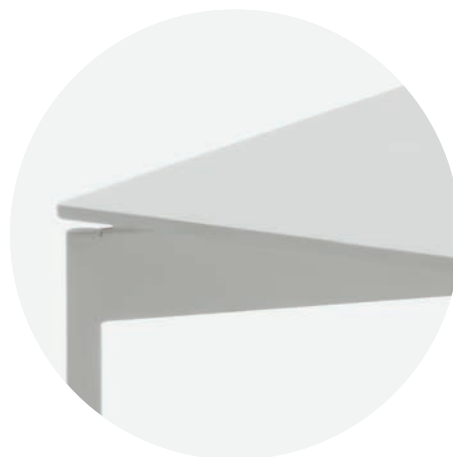

Metal

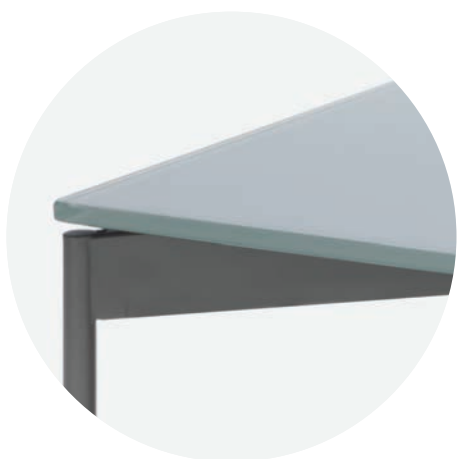

Tempered glass



Modified veneer

Configure your product

When ordering, please use code symbols.

Chic



Shell

Frame / Base

Frame / base colour ^{2, 3, 4}

Upholstery



Chair

20



Metal legs

H



Wooden legs

HW



Chair,
no armrests

21



Swivel,
4-star base ¹

F



Bar stool,
round base

CR



Bar stool,
metal legs

CH



Armchair

10



Armchair

FU



Swivel armchair

FUS



BLACK



METALLIC



EPO1

White



EPO2

Grey



EPO3

Graphite



EPO4 ⁵

Turquoise



EPO5 ⁵

Pink



EPO6 ⁵

Gold



CHROME



SATINE

Lacquer ⁶



H8



H6



H7



H12



H11



H5

Type & colour

SYMBOL

Additional

Glides

HARD

For soft floors.

FELT

For hard floors.

TEFLON

Universal.

Gaslift with memory,
without height
adjustment

Standard:
applicable for 10FUS version.

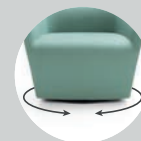

Option: applicable for 21CR,
20CR, 20F versions.



¹ Applicable for 20 version.

⁴ CR version available only in black and chrome.

² Applicable for 20, 21 versions.

⁵ Available in Creative Edition offer from 01.06.2019.

³ F version available only in chrome.

⁶ Applicable for HW version.

Chic Air

Shell



Armchair

A

Backrest and armrests



High backrest, with armrests

10



Wingback, high backrest, with armrests

11

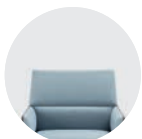

Low backrest, with armrests

20



Chair

C



Low backrest, with armrests

20



Low backrest, without armrests

21



2-seat bench

B

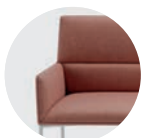

Low backrest, with armrests

20

Frame



Metal legs

H



Wooden legs

HW

Frame colour ¹



BLACK



METALLIC



EPO1

White



EPO2

Grey



EPO3

Graphite



EPO4 ²

Turquoise



EPO5 ²

Pink



EPO6 ²

Gold



CHROME



SATINE

Upholstery

Type & colour

SYMBOL

Option of mixing colours of the same fabric according to below scheme: A – inner part of the shell, B – outer part of the shell. In case of order of such option, following example should be specified: ST-5/ST-6 (where ST-5 – A, ST-6 – B).

It is possible to combine upholstery (Surface A) with Softline or leather (Surface B).

Additional

Glides

HARD

For soft floors.

FELT

For hard floors.

TEFLON

Universal.

¹ Applicable for H version.

² Available in Creative Edition offer from 01.06.2019.

³ Applicable for HW version.

Lacquer ³



H8



H6



H7



H12



H11



H5

Configure your product

When ordering, please use code symbols.

Chic Lounge



Shell

Backrest ¹

Frame / Base

Frame / base colour

Upholstery



Chair

A



Footrest

P



High backrest

10



Low backrest

20











Wire frame

V3



4-star base ¹

F

 BLACK	 METALLIC
 EPO1 White	 EPO2 Grey
 EPO3 Graphite	 EPO4 ² Turquoise
 EPO5 ² Pink	 EPO6 ² Gold
 CHROME	 SATINE ³

Type & colour

SYMBOL

Option of mixing colours of the same fabric according to below scheme: A – inner part of the shell, B – outer part of the shell. In case of order of such option, following example should be specified: ST-5/ST-6 (where ST-5 – A, ST-6 – B).

It is possible to combine upholstery (Surface A) with Softline or Leather Premium (Surface B).

Additional

Cushion for the high backrest



CU

Glides

HARD

For soft floors.

FELT

For hard floors.

TEFLON

Universal.

¹ Applicable for A version.

² Available in Creative Edition offer from 01.06.2019.

³ Not applicable for F version.

Chic Tables ¹

Frame / Base



Round

RR

Height



Ø 800 mm,
h=480 mm

40



Ø 800 mm,
h=660 mm

30



Ø 800 mm,
h=740 mm

20



Ø 800 mm,
h=1100 mm

10



Legs

RH



Ø 800 mm,
h=660 mm

30



Ø 800 mm,
h=740 mm

20

Frame colour ²



BLACK



METALLIC



EPO1

White



EPO2

Grey



EPO3

Graphite



EPO4 ^{3,4}

Turquoise



EPO5 ^{3,4}

Pink



EPO6 ^{3,4}

Gold



CHROME



SATINE

Table top

Tempered glass



G1

Milky



G2

Black



G3

Taupe
(RAL 7044)



G4

Grey (RAL 7042)

Ceramics



CER1

White



CER2

Grey



CER3

Graphite

Metal



EPO1

White



EPO2

Grey



EPO3

Graphite

Modified veneer



HM10

Bleached oak



HM11

Classic oak



HM12

Cardinal oak



HM20

Wenge classic

Additional

Glides

HARD

For soft floors.

FELT

For hard floors.

TEFLON

Universal.

¹ Chic RH / RR tables with metal and ceramic table top (applies only if frame and top are made of EPO1, EPO2, EPO3, with hard or teflon glides) are suitable for outdoor use according to EN 12944-2 cat. C3.

² Frame colour in Chic Restaurant Tables RR applies to column only. Cast iron base always black.

³ Applicable for RH version.

⁴ Available in Creative Edition offer from 01.06.2019.

Configure your product

When ordering, please use code symbols.

Chic Tables

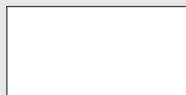

Table



Dimension

Frame colour





Table top



		
Square	1200 x 1200 x 250 mm	800 x 800 x 250 mm
CS	41	40





450 x 450 x 560 mm
30





		
Round	Ø 1200 mm, h=250 mm	Ø 800 mm, h=250 mm
CR	41	40

	
BLACK	METALLIC
	
EPO1 White	EPO2 Grey
	
EPO3 Graphite	EPO4 ¹ Turquoise
	
EPO5 ¹ Pink	EPO6 ¹ Gold
	
CHROME	SATINE

Tempered glass		
		
G1 Milky	G2 Black	G3 Taupe (RAL 7044)
		
G4 Grey (RAL 7042)		

Ceramics		
		
CER1 White	CER2 Grey	CER3 Graphite

Metal ²		
		
EPO1 White	EPO2 Grey	EPO3 Graphite

Modified veneer		
		
HM10 Bleached oak	HM11 Classic oak	HM12 Cardinal oak
		
HM20 Wenge classic		

Additional

Glides	
HARD	For soft floors.
FELT	For hard floors.
TEFLON	Universal.

¹ Available in Creative Edition offer from 01.06.2019.

² Applicable for CS30 version.

Wymiary

Wymiary mają charakter orientacyjny i mogą się różnić w zależności od wybranej konfiguracji produktu.
Metoda pomiaru produktów dostępna do pobrania pod linkiem: www.profim.pl/Metoda_pomiaru_produkow.pdf

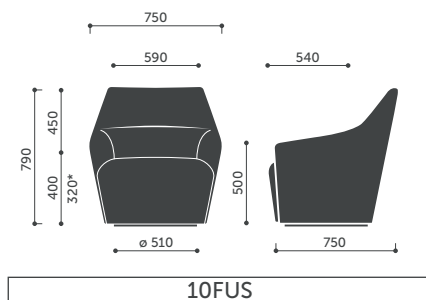
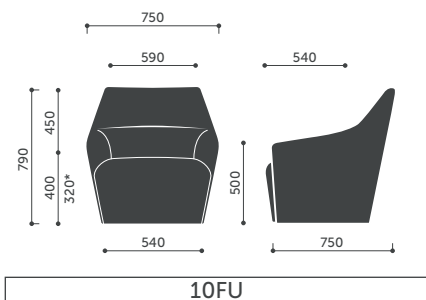
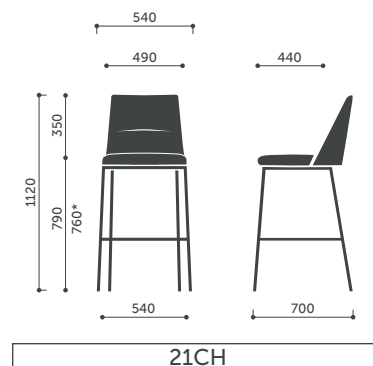
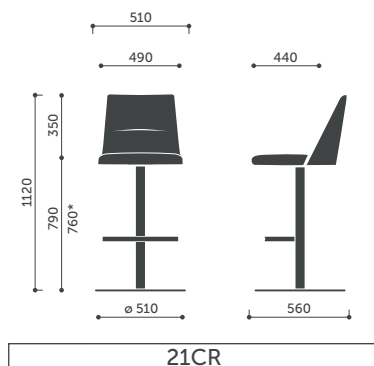
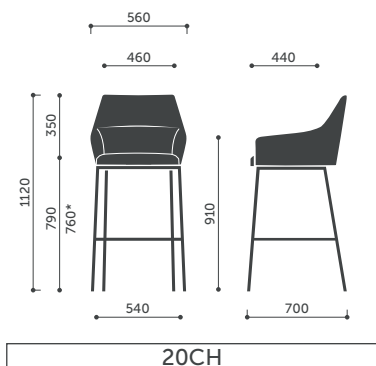
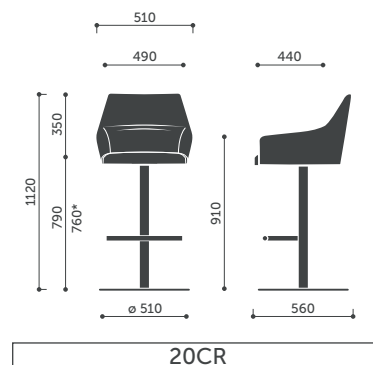
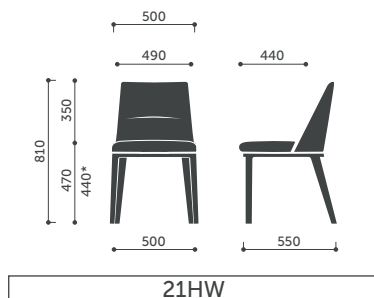
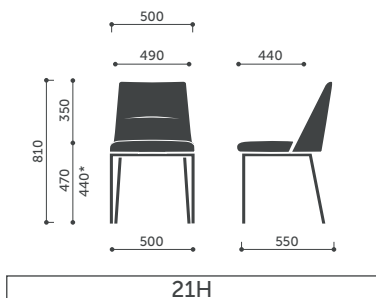
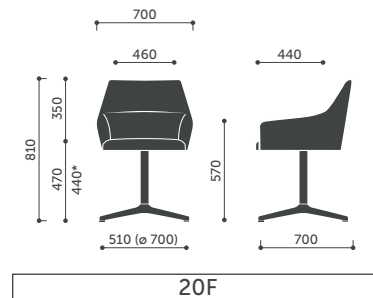
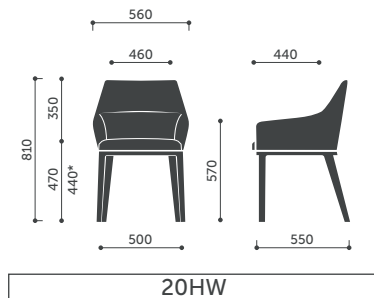
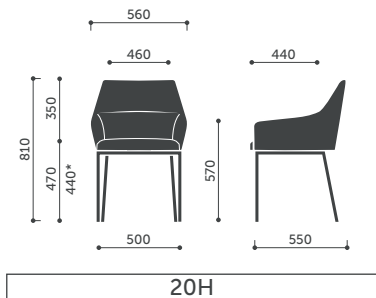

* Wysokość siedziska zmierzona zgodnie z normą PN EN 16139 (z obciążeniem).

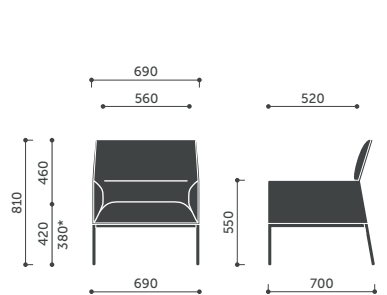

A20H / A20HW

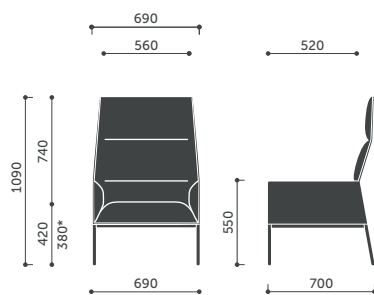

A10H / A10HW

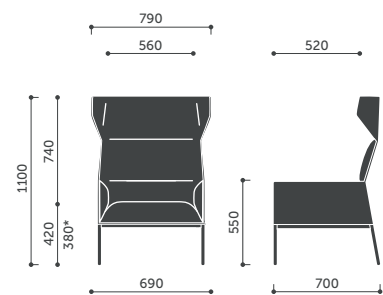

A11H / A11HW

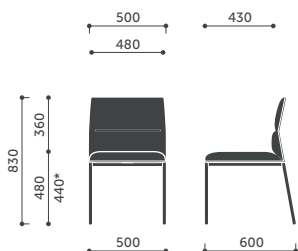

C21H / C21HW

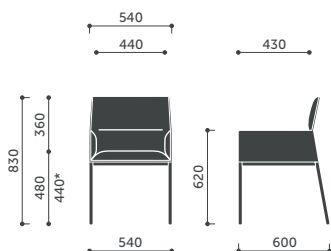

C20H / C20HW

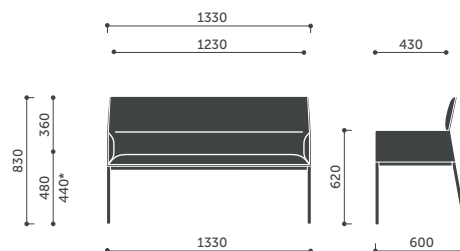

B20H / B20HW

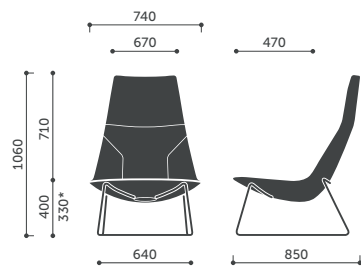

A10V3

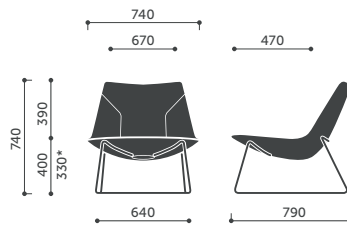

A20V3

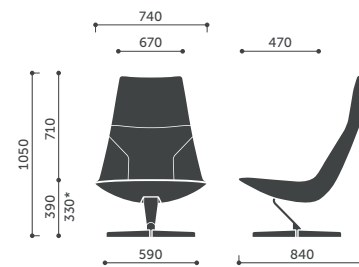

A10F

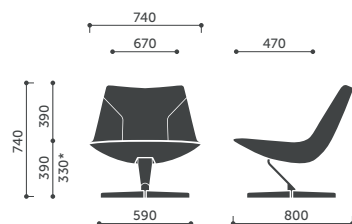

A20F

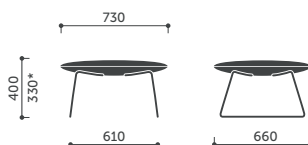

PV3

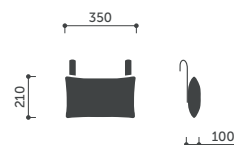

CU

* Wysokość siedziska zmierzona zgodnie z normą PN EN 16139 (z obciążeniem).

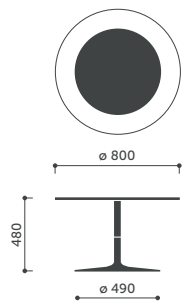

RR40

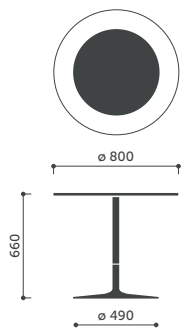

RR30

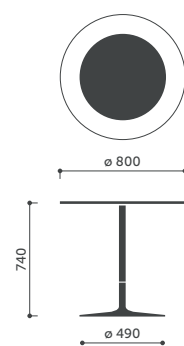

RR20

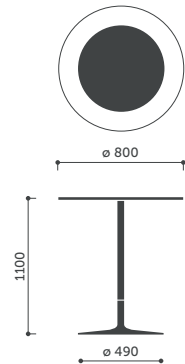

RR10

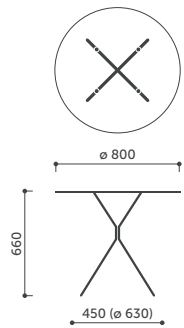

RH30

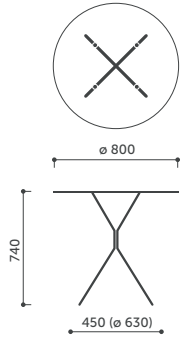

RH20

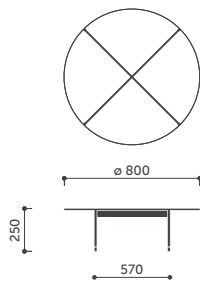

CR40

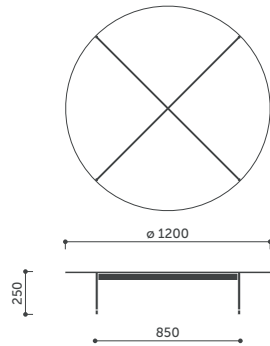

CR41

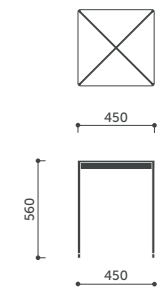

CS30

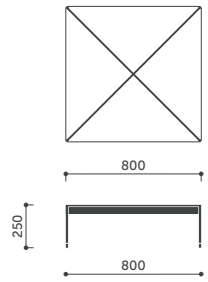

CS40

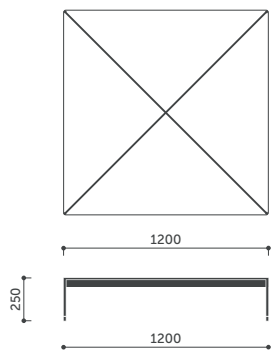

CS41

Profim i środowisko

W naszej działalności stosujemy strategię zrównoważonego rozwoju. Działamy w sposób odpowiedzialny, z korzyścią dla naszych klientów, pracowników, dostawców i lokalnej społeczności, ale zawsze z poszanowaniem środowiska naturalnego.

Dla zapewnienia realizacji zamierzonych celów wdrożyliśmy System Zarządzania Środowiskowego w oparciu o normę ISO 14001, który umożliwia nam kompleksowe podejście do zagadnień ekologii. Bierzymy pod uwagę i oceniamy, jak Chic wpływa na środowisko naturalne w kontekście całego cyklu życia produktu.

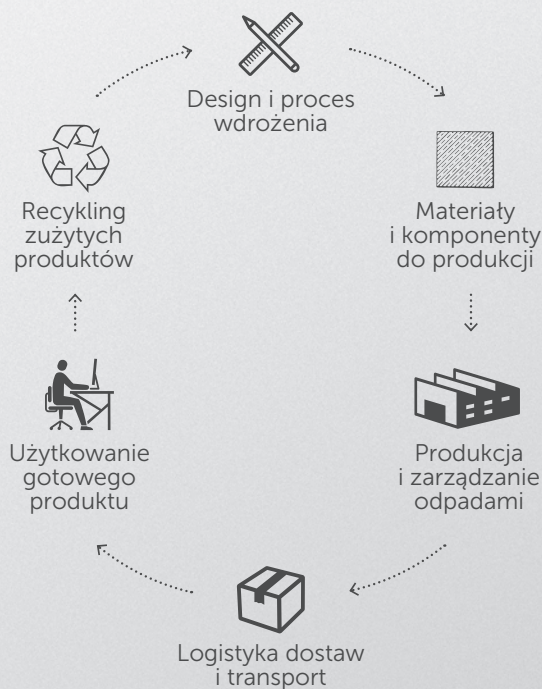

Wykorzystane materiały:

Metale	kg	%
Stal	3,18	26,4
Tworzywa sztuczne	kg	%
Plastik	0,14	1,1
Inne	kg	%
Tapicerka	0,92	7,6
Drewno	5,96	49,5
Pianka PU	1,84	15,4
Waga	12,04	100,0

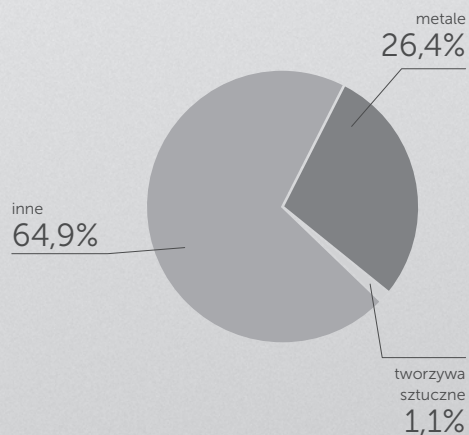

Nadające się do recyklingu



Produkt nie zawiera związków szkodliwych dla ludzi i środowiska (m.in. PVC, chrom(VI), rtęć, ołów).

www.profim.pl

Producent zastrzega sobie prawo do zmian konstrukcyjnych i zmiany parametrów nie pogarszających walorów użytkowych produktów. Kolory reprodukowane w katalogu mogą odbiegać od rzeczywistych kolorów oferowanych mebli.



CHROM (III)
Technologia przyjazna
dla środowiska

CHROMIUM (III)
Eco-Friendly Technology

